

STANDARD SHAPES/ STRUCTURAL SHAPES

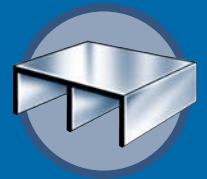
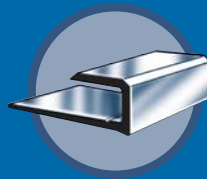
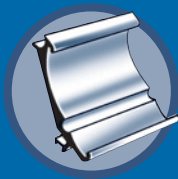
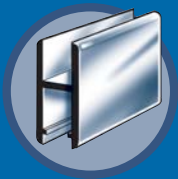

RIGHT SHAPES

RIGHT PRICE

RIGHT NOW



DRAWING	PART NUMBER	DIMENSIONS				LENGTH	FINISH
		E	A	T	I/R		
ANGLES - Equal Leg - Architectural							
	IE 1207	5/8"	5/8"	1/16"		4', 6', 12'	AN
	IE 1208	13/16"	13/16"	0.060"		4', 6', 12'	AN
	IE 1209	1/2"	1/2"	1/16"		8' 4', 6', 12' 21'	AN, BC AN, BC, BK, SB, SS ML
	IE 1210	1/2"	1/2"	0.045"		4', 6', 12'	AN
	IE 1212	3/4"	3/4"	0.045"		4', 6', 12'	AN
	IE 1213	3/4"	3/4"	1/16"		8' 4', 6', 12' 21', 24'	AN, BC, SB AN, BC, BK, BS, SB, SS ML
	IE 1214	1"	1"	0.045"		4', 6' 12'	AN AN, BC
	IE 1215	1"	1"	1/16"		8' 4', 6', 12' 21'	AN, BC, SB AN, BC, BK, BS, SB, SS ML
	IE 1216	1 1/4"	1 1/4"	1/16"		4', 6' 12'	AN, SB AN*, ML, SB
	IE 1218	1 1/2"	1 1/2"	1/16"		4', 6', 12'	AN
	IE 1232	3/4"	3/4"	1/8"		4', 6', 12' 21', 24'	AN, SB ML
	IE 1234	1"	1"	1/8"		4', 6' 8', 12' 21', 24'	AN, SB AN ML
	IE 1235	1 1/4"	1 1/4"	1/8"		21', 24'	ML
	IE 1236	1 1/2"	1 1/2"	1/8"		4', 6' 8' 12' 21', 24'	AN AN, BC AN, BC, SS ML
	IE 1238	2"	2"	1/8"		4', 6' 12' 21', 24'	AN, SB AN ML
	IE 1240	3"	3"	1/8"		4', 6', 12', 24'	AN
	IE 1241	3 1/2"	3 1/2"	1/8"		24'	ML
	IE 1244	1 1/2"	1 1/2"	1/4"		4', 6', 12'	AN
	IE 1250	2"	2"	1/4"		4', 6', 12'	AN

NOTE: *IE 1216, 12' AN only – T dimension is 0.055"

NOTE: Minimum order quantities may apply on 20ft, 21ft and 24ft material.

FINISHES: AN-Anodized, BC-Brite Clear, BK-Brite Black, BS-Brass, ML-Mill, SB-Satin Black, SS-Stainless Steel Brushed

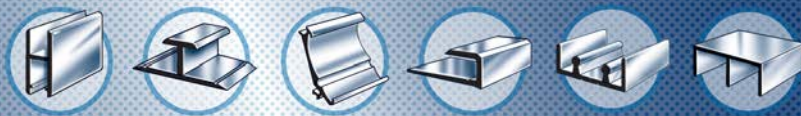

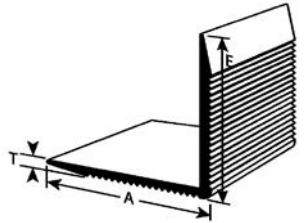
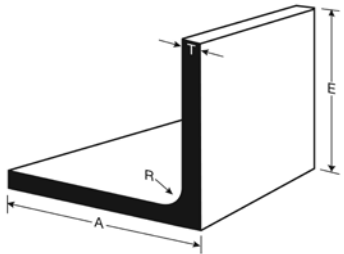
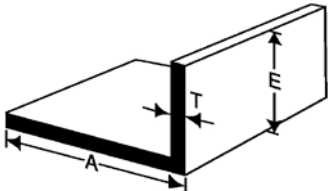
DRAWING	PART NUMBER	DIMENSIONS				LENGTH	FINISH
		E	A	T	I/R		
ANGLES - Equal Leg - Architectural							
	IE 5892	1 1/2"	1 1/2"	3/32"		4', 6', 12'	ML
ANGLES - Rounded Inside Equal Leg - Structural							
	IE 1316	1 1/4"	1 1/4"	1/8"	0.125"	20'	ML
	IE 1334	1"	1"	1/8"	0.125"	20'	ML
	IE 1336	1 1/2"	1 1/2"	1/8"	0.125"	20'	ML
	IE 1338	2"	2"	1/8"	0.125"	20'	ML
	IE 1339*	2 1/2"	2 1/2"	3/16"	0.188"	20'	ML
	IE 1344	1 1/2"	1 1/2"	1/4"	0.250"	20'	ML
	IE 1350	2"	2"	1/4"	0.250"	20'	ML
	IE 1351	2 1/2"	2 1/2"	1/4"	0.250"	20'	ML
	IE 1352	3"	3"	1/4"	0.250"	20'	ML
	IE 1354	4"	4"	1/4"	0.250"	20'	ML
	IE 1356	6"	6"	3/8"	0.375"	20'	ML
	IE 1362	2"	2"	3/8"	0.375"	20'	ML
ANGLES - Unequal Leg - Architectural							
	IE 1406	1/4"	3/4"	1/16"		4', 6' 12'	AN AN, BC
	IE 1408	3/8"	7/8"	1/16"		4', 6', 12'	AN, BZ, SB
	IE 1410	1/2"	3/4"	0.050"		8' 4', 6', 12'	AN AN, BC
	IE 1411	1/2"	1"	1/16"		8' 4', 6', 12'	AN AN, BC, SS
	IE 1412	1"	1 1/2"	1/16"		4', 6', 12'	AN
	IE 1413	3/4"	1"	0.062"		4', 6', 12'	AN
	IE 1414	1"	2"	1/16"		4', 6', 12'	AN
	IE 1416	3/4"	1 1/2"	1/16"		4', 6' 8' 12'	AN, SB SB AN, BC, SB

*Min. 550 lb. order is required.

NOTE: Minimum order quantities may apply on 20ft, 21ft and 24ft material.

FINISHES: AN-Anodized, BC-Brite Clear, BZ-Bronze, ML-Mill, SB-Satin Black, SS-Stainless Steel Brushed



DRAWING	PART NUMBER	DIMENSIONS				LENGTH	FINISH
		E	A	T	I/R		
ANGLES - Unequal Leg - Architectural							
	IE 1432	1/2"	1"	1/8"		4', 6' 12'	AN, SB AN
	IE 1434	3/4"	1"	1/8"		4', 6', 12' 21', 24'	AN ML
	IE 1435	3/4"	1 1/2"	1/8"		4', 6' 8' 12' 21'	AN, SS AN AN, BC, SS ML
	IE 1436	1"	1 1/2"	1/8"		4', 6', 12' 21'	AN ML
	IE 1437	1 1/2"	2"	1/8"		21', 24'	ML
	IE 1438	1"	2"	1/8"		4', 6' 12' 21', 24'	AN, SB AN ML
	IE 1440	1"	3"	1/8"		4', 6', 12' 21', 24'	AN ML
	IE 1446	2"	4"	1/8"		12'	AN
	IE 1460	3/4"	4 1/4"	0.075"		10'	BC, SS
	ANGLES - Rounded Inside Unequal Leg - Structural						
	IE 1537	2"	1 1/2"	1/4"	0.250"	20'	ML
	IE 1544	2 1/2"	1 1/2"	1/4"	0.250"	20'	ML
	IE 1545	3"	2"	1/4"	0.250"	20'	ML
	IE 1548	1 1/2"	2 1/2"	3/16"	0.187"	20'	ML
	IE 1560	3"	5"	1/4"	0.250"	20', 24'	ML

NOTE: Minimum order quantities may apply on 20ft, 21ft and 24ft material.

FINISHES: AN-Anodized, BC-Brite Clear, BS-Brass, ML-Mill, SB-Satin Black, SS-Stainless Steel Brushed

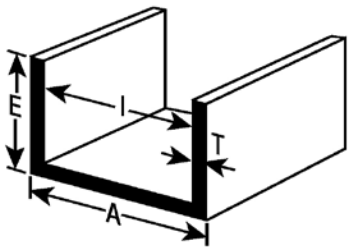

DRAWING	PART NUMBER	DIMENSIONS				LENGTH	FINISH
		E	A	T	I/R		
CHANNEL - Architectural							
	IE 1605	1/4"	1/4"	1/16"	0.125"	4', 6', 12'	AN, ML
	IE 1610	3/8"	3/8"	1/16"	1/4"	4', 6' 8' 12'	AN, BC, SS AN, SS AN, BC, BS, SS
	IE 1611	3/8"	1/2"	1/16"	0.375"	4', 6', 12'	AN
	IE 1612	1/2"	3/8"	0.045"	0.270"	4', 6', 12'	AN, BC, SS
	IE 1613	1 1/4"	1/2"	1/16"	3/8"	4', 6', 12'	AN
	IE 1614	1/2"	1/2"	1/16"	3/8"	4', 6' 8', 12' 24'	AN, BC, SB AN, BC ML
	IE 1615	3/4"	0.524"	1/16"	0.398"	4', 6', 8', 12'	BC, SS
	IE 1616	5/8"	5/8"	1/16"	1/2"	4', 6', 8', 12'	AN, BC
	IE 1617	5/8"	3/4"	1/16"	5/8"	8' 4', 6', 12'	AN AN, BC
	IE 1618	5/8"	7/8"	1/16"	3/4"	4', 6' 8' 12'	AN, BC, SB AN, BC AN, BC, BS, SB
	IE 1619	5/8"	1"	1/16"	7/8"	4', 6', 12'	AN
	IE 1620	5/8"	1 1/8"	0.055"	1"	4', 6' 12'	AN AN, BZ
	IE 1621	3/4"	9/16"	0.060"	7/16"	4', 6' 8' 12'	AN, BC, BK, SB, SS AN, SS AN, BC, BK, BS, BZ, SS
	IE 1622	3/8"	9/16"	1/16"	7/16"	4', 6' 12'	AN, BC AN, BK
	IE 1623	3/4"	3/4"	1/16"	5/8"	4', 6', 12'	AN
	IE 1624	1"	5/8"	1/16"	1/2"	4', 6' 8' 12'	AN, BC, SB, SS AN, BC AN, BC, BK, BS

NOTE: Minimum order quantities may apply on 20ft, 21ft and 24ft material.

FINISHES: AN-Anodized, BC-Brite Clear, BK-Brite Black, BS-Brass, BZ-Bronze, ML-Mill, SB-Satin Black, SS-Stainless Steel Brushed



DRAWING	PART NUMBER	DIMENSIONS				LENGTH	FINISH
		E	A	T	I/R		
CHANNEL - Architectural							
	IE 1633	3/4"	3/4"	3/32"	9/16"	4', 6', 12'	AN, BC
	IE 1634	3/4"	3/4"	1/8"	1/2"	4', 6', 12' 21', 24'	AN ML
	IE 1636	3/4"	1"	1/8"	3/4"	4', 6', 12'	AN
	IE 1638	1/2"	1"	1/8"	3/4"	4', 6', 12' 21', 24'	AN ML
	IE 1639	5/8"	1 1/4"	1/8"	1"	4', 6', 12'	AN
	IE 1640	1/2"	1 1/2"	1/8"	1 1/4"	4', 6', 12' 21', 24'	AN ML
	IE 1641	1/2"	3/4"	1/8"	1/2"	4', 6', 12'	AN
	IE 1642	1"	1"	1/8"	3/4"	4', 6' 12' 21', 24'	AN, BC, SB, SS AN, BC, SS ML
	IE 1643	1 1/2"	1"	1/8"	3/4"	4', 6' 12' 24'	AN, BC, SB, SS AN, BC, SS ML
	IE 1644	1"	1 1/2"	1/8"	1 1/4"	4', 6', 8' 12' 24'	AN AN, ML ML
	IE 1645	3/4"	1 3/4"	0.090"	1 1/2"	4', 6', 12'	AN
	IE 1646	1"	2"	1/8"	1 3/4"	4', 6', 12' 24'	AN ML
	IE 1647	1/2"	2"	1/8"	1 3/4"	4', 6', 12'	AN, SB
	IE 1648	1"	3"	1/8"	2 3/4"	4', 6', 12'	AN
	IE 1650	2"	1"	1/8"	3/4"	4', 6' 12' 24'	AN, SB, SS AN, SS ML
	IE 1651	1 1/2"	1 1/2"	1/8"	1 1/4"	21', 24'	ML
	IE 1654	2"	1 3/4"	1/8"	1 1/2"	4', 6', 12'	AN

NOTE: Minimum order quantities may apply on 20ft, 21ft and 24ft material.

FINISHES: AN-Anodized, BC-Brite Clear, ML-Mill, SB-Satin Black, SS-Stainless Steel Brushed



DRAWING	PART NUMBER	DIMENSIONS				LENGTH	FINISH
		E	A	T	I/R		
CHANNEL - Rounded Outside - Architectural							
	IE 1625*	3/8"	9/16"	0.080"	0.403"	4', 6' 12'	BC
	IE 1626*	3/8"	0.678"	0.080"	0.518"	4', 6', 12'	AN, BC, SB, SS
	IE 1627*	3/4"	9/16"	0.080"	0.403"	4', 6', 98", 12'	AN, BC, SB, SS
	IE 1628*	3/4"	0.678"	0.080"	0.518"	4', 6', 12'	AN, BC, SB, SS
CHANNEL - Rounded Inside - Structural							
	IE 1729	1 1/2"	2"	1/8"	0.125"	24'	ML
	IE 1754	2"	3"	1/4"	0.188"	20'	ML
	IE 1755	2"	4"	3/16"	0.375"	20'	ML
	IE 1756	1 1/2"	3"	1/4"	0.312"	20'	ML
	IE 1757	2"	6"	0.281"	0.437"	24'	ML
	IE 1760	2"	4"	1/4"	0.250"	24'	ML
	IE 1776	3"	8"	9/32"	0.500"	24'	ML
	IE 1778	2 1/2"	6"	1/4"	0.437"	20'	ML
	IE 1782	3"	10"	9/32"	0.562"	20'	ML
T BAR - Architectural							
	IE 1830	3/4"	3/4"	1/8"		4', 6', 12'	AN
	IE 1831	1"	2"	1/8"		4', 6', 12'	ML
	IE 1832	1"	1"	1/8"		4', 6', 12'	AN, ML
	IE 1834	2"	2"	1/8"		4', 6', 12'	AN
	IE 1837	2"	1"	0.118"		4', 6', 12'	ML
T BAR - Rounded Inside - Structural							
	IE 1936	1 1/2"	1 1/2"	3/16"	0.188"	12', 24'	ML
	IE 1938	2"	2"	1/4"	0.250"	24'	ML

*Radius Dimensions: R1 - 0.031", R2 - 0.063", R3 - 0.031"

NOTE: Minimum order quantities may apply on 20ft, 21ft and 24ft material.

FINISHES: AN-Anodized, BC-Brite Clear, ML-Mill, SB-Satin Black, SS-Stainless Steel Brushed



DRAWING	PART NUMBER	DIMENSIONS				LENGTH	FINISH
		E	A	T	I/R		
SOLID BAR - Half Oval							
	IE 2013	9/64"	3/8"			4', 6', 12'	AN
	IE 2014	9/64"	1/2"			12'	AN, BC
	IE 2016	3/16"	3/4"			4', 6', 12'	AN, BC
	IE 2018	3/16"	1"			4', 6', 12'	AN
SOLID BAR - Square							
	IE 2406	1/4"	1/4"			4', 6', 12'	AN, BC AN, BC, ML
	IE 2408	1/2"	1/2"			4', 6', 12'	AN AN, ML
	IE 2409	3/4"	3/4"			12'	ML
	IE 2466	1"	1"			12'	ML
	IE 2490	1 1/2"	1 1/2"			12'	ML
SOLID BAR - Rectangular							
	IE 2312	1/16"	1/2"			6', 12'	AN AN, ML
	IE 2314	1/16"	3/4"			4', 6', 12'	AN AN, ML
	IE 2316	1/16"	1"			4', 6', 12'	AN, ML
	IE 2318	1/16"	1 1/2"			4', 6', 12'	AN, ML
	IE 2410	1/8"	3/8"			4', 6', 12'	AN AN, BC
	IE 2412	1/8"	1/2"			4', 6', 8', 12'	AN, BC, BK
	IE 2413	1/8"	5/8"			4', 6', 12'	AN
	IE 2414	1/8"	3/4"			4', 6', 8', 12', 20'	AN, BC, BS, SB AN AN, BC ML
	IE 2416	1/8"	1"			4', 6', 12', 8', 20', 24'	AN, BC, SB AN ML

NOTE: Minimum order quantities may apply on 20ft, 21ft and 24ft material.

FINISHES: AN-Anodized, BC-Brite Clear, BK-Brite Black, BS-Brass, ML-Mill, SB-Satin Black



STANDARD SHAPES

DRAWING	PART NUMBER	DIMENSIONS				LENGTH	FINISH
		E	A	T	I/R		
SOLID BAR - Rectangular							
	IE 2418	1/8"	1 1/2"			4', 6' 12' 20', 24'	AN, BC AN, BC, BZ, SB ML
	IE 2420	1/8"	2"			4', 6' 12' 20', 24'	AN AN, BS ML
	IE 2421	1/4"	1/2"			20'	ML
	IE 2426	1/8"	3"			4', 6', 12' 20'	AN ML
	IE 2428	1/8"	4"			4', 6', 12' 20'	AN ML
	IE 2429	1/4"	3/4"			12' 20'	AN, ML ML
	IE 2430	1/4"	1"			4', 6' 12' 20'	AN AN, BC, ML ML
	IE 2431*	1/4"	1 3/4"			12', 20'	ML
	IE 2432	1/4"	1 1/2"			4', 6' 12' 20'	AN AN, ML ML
	IE 2434	1/4"	2"			4', 6', 12' 20'	AN, ML ML
	IE 2436	3/8"	3/4"			12', 20'	ML
	IE 2437	1/4"	3"			12'	ML
	IE 2438	3/8"	1"			12', 20'	ML
	IE 2439	1/4"	4"			12', 20'	ML
	IE 2440	1/4"	5"			12', 20'	ML
	IE 2441	3/4"	1"			10', 12', 20'	ML
	IE 2442	1/2"	3/4"			12', 20', 24'	ML
	IE 2443	1/4"	6"			12', 20'	ML
	IE 2444	1/2"	1"			12', 20'	ML

*Min. 550 lb. order required on 12ft length only.

NOTE: Minimum order quantities may apply on 20ft, 21ft and 24ft material.

FINISHES: AN-Anodized, BC-Brite Clear, BS-Brass, BZ-Bronze, ML-Mill, SB-Satin Black



DRAWING	PART NUMBER	DIMENSIONS				LENGTH	FINISH
		E	A	T	I/R		
SOLID BAR - Rectangular							
	IE 2446	3/8"	2 1/2"			20'	ML
	IE 2447	3/16"	2 1/2"			20'	ML
	IE 2448	1/2"	1 1/2"			12', 20'	ML
	IE 2449	1/4"	3 1/2"			12', 20'	ML
	IE 2450	1/2"	2"			12', 20'	ML
	IE 2454	3/8"	1 1/2"			12', 20'	ML
	IE 2455	1/2"	3"			12', 20'	ML
	IE 2458	3/4"	3"			12', 20'	ML
	IE 2459	1/2"	4"			12', 20'	ML
	IE 2460	1/2"	5"			12'	ML
	IE 2461	1/4"	1 1/2"			12', 20'	ML
	IE 2468	1/4"	8"			12', 20'	ML
	IE 2470	1"	1 1/2"			12', 20'	ML
	IE 2473	3/8"	3"			12'	ML
	IE 2480	1"	2"			12', 20'	ML
IE 2482	1"	3"			12', 20'	ML	
SOLID BAR - Round							
	IE 2809	15/64"				12'	ML
	IE 2810	1/4"				4', 6', 12'	AN, BC, AN, BC, ML
	IE 2812	3/8"				4', 12', 24'	AN, ML ML
	IE 2814	1/2"				4', 6', 12'	AN ML
	IE 2815	5/8"				12'	ML
	IE 2816	3/4"				12'	BC, ML
	IE 2817	7/8"				12'	ML
	IE 2818	1"				12'	ML
	IE 2822	1 1/2"				12'	ML
	IE 2824	2"				12'	ML
	IE 2826	2 1/2"				12'	ML
	IE 2828	3"				12'	ML

NOTE: Minimum order quantities may apply on 20ft, 21ft and 24ft material.

FINISHES: AN-Anodized, BC-Brite Clear, ML-Mill

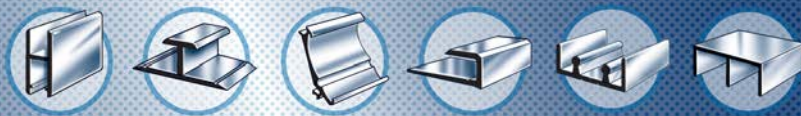

DRAWING	PART NUMBER	DIMENSIONS				LENGTH	FINISH
		E	A	T	I/R		
HOLLOW TUBE - Round							
	IE 3009	0.480"	0.039"			12'	ML
	IE 3012	1/2"	0.050"			4', 6', 12'	AN, BC
	IE 3014	5/8"	0.065"			4', 6', 12'	AN
	IE 3016	3/4"	0.050"			4', 6', 12'	AN
	IE 3017	3/4"	0.065"			12'	AN
						21'	ML
	IE 3018	7/8"	1/16"			4', 6', 12'	AN
						21'	ML
	IE 3030	1"	0.050"			4', 6', 12'	AN
	IE 3034	1 1/2"	1/16"			4', 6', 12'	AN
						12', 24'	ML
	IE 3036*	2"	1/16"			12'	AN, ML
						20'	ML
	IE 3038	3"	1/16"			12'*	ML
	IE 3039	2"	1/8"			20'	ML
	IE 3040	1"	1/8"			12', 20'	ML
	IE 3042	1 1/2"	1/8"			12'	AN, ML
						20'	ML
	IE 3043	2 1/2"	1/16"			12'*	AN, ML
	IE 3044	2 1/2"	1/8"			12'*	AN, ML
IE 3046	3"	1/8"			12', 20'	ML	
IE 3048	4"	1/8"			12'	AN, ML	
					20'	ML	
IE 3050*	5"	1/8"			12'	AN, ML	
					20'	ML	
IE 3060	6"	1/8"			12'	AN, ML	

*Min. 550 lb. order is required on ML only.

NOTE: While some of our Round, Square and Rectangular Hollow Tubes might seem like they can fit inside one another, the only Tubes we guarantee will marry together are our Telescopic Tubes. All other Hollow Tubes are industry standard profiles that have not been designed to fit together.

NOTE: Minimum order quantities may apply on 20ft, 21ft and 24ft material.

FINISHES: AN-Anodized, BC-Brite Clear, ML-Mill

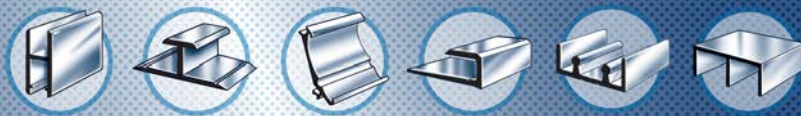

DRAWING	PART NUMBER	DIMENSIONS				LENGTH	FINISH
		E	A	T	I/R		
HOLLOW TUBE - Square							
	IE 3210	1/2"	1/2"	1/16"		4', 6' 12'	AN AN, ML
	IE 3211	5/8"	5/8"	1/16"		4', 6' 12'	AN AN, ML
	IE 3212	3/4"	3/4"	0.050"		4', 6', 12'	AN
	IE 3214	1"	1"	1/16"		4', 6' 12', 21' 24'	AN, BC AN, ML ML
	IE 3216	1 1/2"	1 1/2"	0.050"		4', 6' 4', 8' 12'	AN BC AN, ML
	IE 3228	3/4"	3/4"	1/8"		12' 20'	BZ AN, ML
	IE 3230	1"	1"	0.120"		4', 6' 12' 21', 24'	AN AN, ML AN, ML
	IE 3233	1 1/2"	1 1/2"	0.095"		21', 24'	ML
	IE 3234	1 1/2"	1 1/2"	1/8"		4', 6', 12' 21'	AN ML
	IE 3235	1 3/4"	1 3/4"	0.120"		21', 24'	ML
	IE 3236	2"	2"	1/8"		4', 6' 12', 20', 21', 24'	AN ML
	IE 3239	2 1/2"	2 1/2"	1/8"		12', 24'	ML
	IE 3240	3"	3"	0.125"		24'	ML
	IE 3260	4"	4"	1/4"		20'	ML

NOTE: While some of our Round, Square and Rectangular Hollow Tubes might seem like they can fit inside one another, the only Tubes we guarantee will marry together are our Telescopic Tubes. All other Hollow Tubes are industry standard profiles that have not been designed to fit together.

NOTE: Minimum order quantities may apply on 20ft, 21ft and 24ft material.

FINISHES: AN-Anodized, BC-Brite Clear, BZ-Bronze, ML-Mill

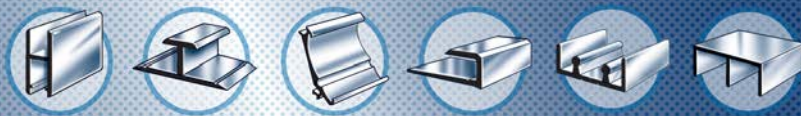

DRAWING	PART NUMBER	DIMENSIONS				LENGTH	FINISH
		E	A	T	I/R		
HOLLOW TUBE - Rectangular							
	IE 3410	1"	1.5"	1/8"		12' 21'	AN, ML ML
	IE 3411*	1"	2"	0.095"		24'	ML
	IE 3412	1"	2"	1/8"		4', 6' 12'	AN AN, ML
	IE 3413	1"	2"	1/8"		24'	AN, ML
	IE 3414	1"	3"	0.120"		12' 24'	AN, ML ML
	IE 3416	1 1/4"	3"	1/8"		4', 6', 12'	AN
	IE 3419	1"	4"	1/8"		24'	ML
	IE 3420	2"	4"	1/8"		12'* 21' 24'	ML AN, ML ML
	IE 3423	1 1/2"	2"	1/8"		24'	ML
	IE 3426	2"	6"	1/8"		24'	ML
	IE 3428	1 3/4"	4"	1/8"		12'*	ML
	IE 3430	1 3/4"	5"	1/8"		12'*	ML
	IE 3433	1 3/4"	4"	3/32"		12'*	ML
	IE 3434	1 3/4"	4 1/2"	0.090"		21'*	ML
	HOLLOW TUBE - Telescopic (IE3213, IE3215 and IE3232 are the only telescopic tubes designed to fit together)						
	IE 3213	3/4"	3/4"	0.100"	**	12', 24'	ML
	IE 3215	1 1/4"	1 1/4"	0.090"	**	12', 24'	ML
	IE 3217	1 1/4"	1 1/4"	0.120"	**	12', 24'	ML
	IE 3219	1.530"	1.530"	1/8"	**	12', 24'	ML
	IE 3220	1"	1"	0.062"	**	12', 24'	ML
	IE 3232	1"	1"	0.120"	**	12', 24'	ML
	IE 3237	2"	2"	0.120"	**	20'	ML

*Min. 550 lb. order is required.

** Radius Dimensions:

P/No.	Outside radius	Inside radius
IE-3213	0.100"	0.100"
IE-3215	0.188"	0.098"
IE-3217	0.188"	0.068"
IE-3219	0.200"	0.200"
IE-3220	0.162"	0.100"
IE-3232	0.120"	0.120"
IE-3237	0.188"	0.250"

NOTE: While some of our Round, Square and Rectangular Hollow Tubes might seem like they can fit inside one another, the only Tubes we guarantee will marry together are our Telescopic Tubes. All other Hollow Tubes are industry standard profiles that have not been designed to fit together.

NOTE: Minimum order quantities may apply on 20ft, 21ft and 24ft material.

FINISHES: AN-Anodized, ML-Mill



DRAWING	PART NUMBER	DIMENSIONS				LENGTH	FINISH
		E	A	T	I/R		
THRESHOLD							
	IE 5824***	1/4"	4"			3', 4', 6', 12'	ML
	IE 5825***	1/4"	5"			3', 4', 6', 12'	ML
	IE 5826***	1/4"	6"			3', 4', 6', 12'	ML
	IE 5834***	1/2"	4"			3', 4', 6', 12'	ML
	IE 5835***	1/2"	5"			3', 4', 6', 12'	ML
	IE 5836***	1/2"	6"			3', 4', 6', 12'	ML
	IE 5847	0.185"	2 1/2"			4', 6', 12'	ML

*****Threshold Details:**

3, 4 and 6 foot lengths are drilled.
12 foot lengths are not drilled.